

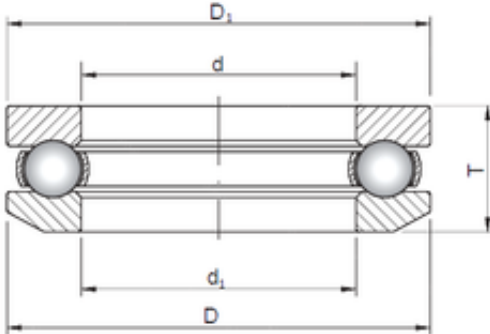

ISO 53236 thrust ball bearings



Bearing No. 53236

Bore Diameter	180 mm
Outer Diameter	245 mm
d	180 mm
d1	183 mm
D	245 mm
D1	250 mm
T	58,2 mm

53236 Bearing 2D drawings and 3D CAD models